

Hickory Rotisseries

Models: N/45WDG , 45WDG PLUS



INDEX

<u>I. INITIAL STEPS</u>	4
1. Placing the Machine	4
2. Assembling the Machine	4
3. Electrical Connection	4
4. Gas Connection	4
5. Venting	4
1.0 Installation Instructions	5
1.1 General Information	5
1.2 Description of the Data Plate	5
1.3 Machine Drawings and Dimensions	6
1.4 Conversion and Adjustment Instructions	7
1.6 Adjustments and Verification for use with Natural Gas	7
1.7 Natural Gas Flow Table (Consumption)	8
1.7.1 Volumetric Method to Verify the High Flame Setting, Mathematical	8
1.8 Orifice Diameters, Primary Air Intake Settings, and Pressure Regulators	9
1.9 Changing Gas Orifices	10
1.9.1 Changing the Main Gas Orifice	10
1.9.2 Changing the Pilot Gas Orifice	11
1.10 Checking the Connected Gas Pressure (Nominal Pressure)	12
1.11 Maintenance, Response to Technical Problems, and Solutions	12
1.12 Testing or Checking for Safety	13
1.14 Description of the Electrical Connection	14
1.15 Electrical Diagram	14
1.16 Parts List for N/ 45G	15
1.17 Parts List explosion diagram	17

<u>II. OPERATING INSTRUCTIONS</u>	20
1. Start Up	20
2. Shut Down	20
3. Working with the Rotisserie	21
4. Cooking Times	22
5. Spitting Chickens	23
A. Using Angle Spits	23
B. Using Regular Spits	28
6. Loading and Unloading Spits	33
7. Checking Chickens for Doneness	34
8. Cooking other Products	34
9. Cleaning	34
10. Maintenance	36
<u>III. CRITICAL CONTROL STEPS FOR PREPARATION AND COOKING OF BARBECUE CHICKENS</u>	37
<u>IV. WARRANTY</u>	38

I. INITIAL STEPS

1. Placing the Machine

Barbecue products are often bought on impulse. The continuous style rotisserie models have been designed for maximum viewing by both the customers as well as the operator. The unit usually has a front glass surface and should be placed where it will get the best and most exposure. Wherever the unit is placed, remember that the operator will need continual access through the glass doors.

**WARNING: THESE MACHINES ARE OVENS AND SHOULD NEVER BE PLACED WITHIN PUBLIC ACCESS.
FOLLOW MINIMUM CLEARANCE REQUIREMENTS FOR ALL UNITS AS PER SPECIFICATION GUIDES.**

2. Assembling the Machine

The N/45G come fully assembled except for the glass, spits, skewers, baskets and thumb screws, which are individually packed. Check all parts and accessories with your packing list. Remove all tape on glass and vinyl coating on stainless steel before operating the machine.

3. Electrical Connection

The electrical connections on the N/45G is less than 15 amps, 120V, so just connect the plug supplied with the unit into a regular outlet.

4. Gas Connection

The N/45G gas connection must be performed by a *licensed gas fitter*. All units are supplied with a main shut off valve (*gas cock*) and a pressure regulator.

5. Venting

The N/45G is fully opened along the top for air evacuation and must be placed under a canopy type hood.

II Installation Instructions

1.1 General Information

The Operating Instructions are to be given to the operator of the rotisserie. All unit operators are to be familiar with the functions of the rotisserie.

The Operating Instructions should be kept in a location close to the rotisserie. It should be easily recognizable and easily accessible.

These rotisseries can be used with both natural and LPG gases. The rotisseries can be converted or adjusted to any type of the locally distributed natural and LPG gases.

It is recommended that a repair and maintenance contract be signed with the manufacturer's agent, distributor, or service agency.

1.2 Description of the Data Plate

HICKORY INDUSTRIES, INC.	
COMMERCIAL COOKING APPLIANCES	
NORTH BERGEN, NJ 07047	
MODEL	N/45 SERIAL NO. <input type="text"/>
MOTOR: 110 - 115 VOLTS 60 CYCLE AC CURRENT 1/3 HP SINGLE PHASE 1725 RPM	
BURNERS	<input type="text" value="3"/> *4 burners for 45 Plus
LISTED  69D6	GAS INPUT PER BURNER <input type="text" value="60,000"/> BTU/H
MANIFOLD PRESSURE	<input type="text" value="5.5"/>
TYPE OF GAS	<input type="text" value="NAT"/>
MFG. DATE	<input type="text"/>
MINIMUM INSTALLATION CLEARANCE SIDE: 6 INCHES BACK: 6 INCHES MAXIMUM LAMP WATTAGE: 150 WATTS FOR INSTALLATION ON A COMBUSTIBLE FLOOR Gas-fired Food Service Equipment Classified by Underwriters Laboratories Inc. In accordance with American National Standards Institute ANSI Z 83.11b-1991, Gas Food Service Equipment-Ranges and Unit Boilers	

WARNING!

This unit must be installed and connected in accordance to the latest regulations and can only be operated in conjunction with forced ventilation or exhaust hood.

This unit has been designed for professional use only and may only be installed or repaired by licensed service agencies!

Before installing or using this equipment, read these instructions!

1.3 Machine Drawings and Dimensions

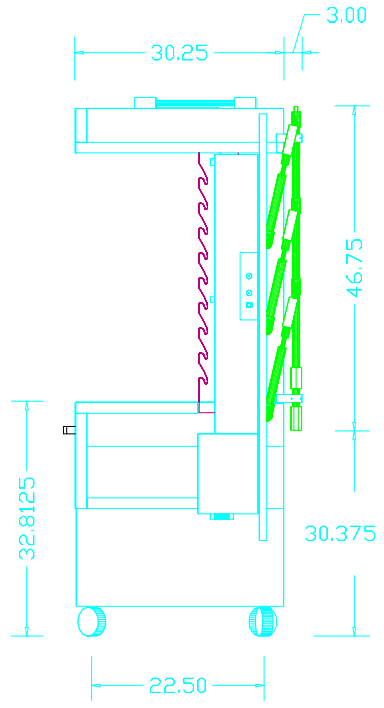
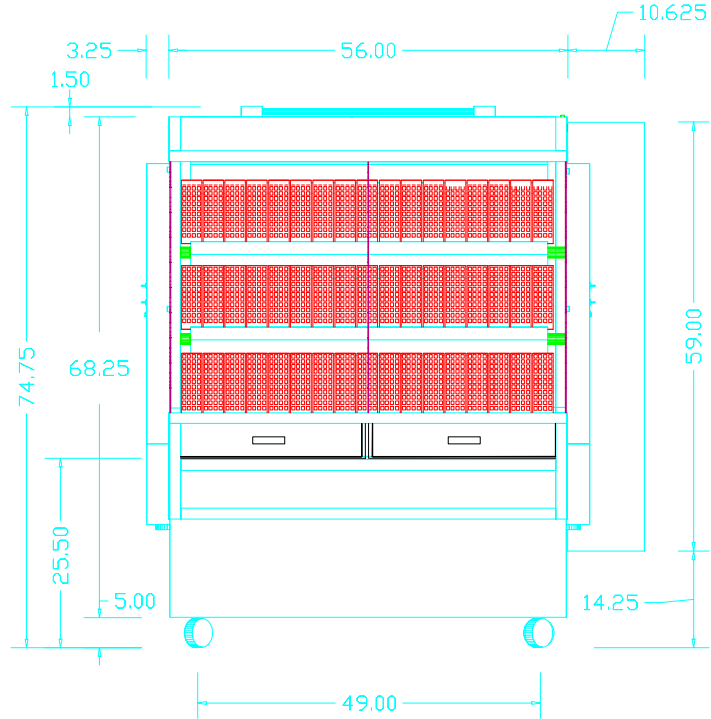
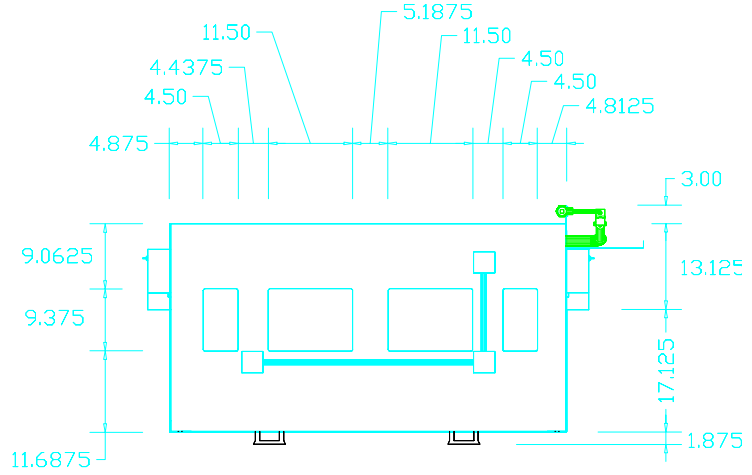

1.4 Conversion and Adjustment Instructions

Before converting or adjusting the machine, it is imperative that the manual gas cock be turned to the "off" position. The electrical power to the machines should also be turned off. When converting from one type of gas to another, the main gas orifice (or injector), the pilot burner orifice (or injector), and the primary air adjustment must be changed according to the table on page 9. In addition, the spring in the pressure regulator must be changed so that it can operate at higher pressures.

1.6 Verification for use with Natural Gas

The highest flame setting ("on" position on the manifold gas valves) for each of the pipe burners can be confirmed by using the volumetric method in conjunction with the main gas meter. From the "pilot" position, turn the Gas Control Lever clock-wise, towards "on", until the lever goes no further.

To carry out this verification procedure, it is necessary to obtain the heating value (BTU/ft³) of the local gas from the local gas company.

If the measured gas volume does not correspond to the values in the following table, the first item which should be checked is the incoming (connected) gas pressure. If the pressure is correct, it must be verified that the proper size gas orifices are in place.

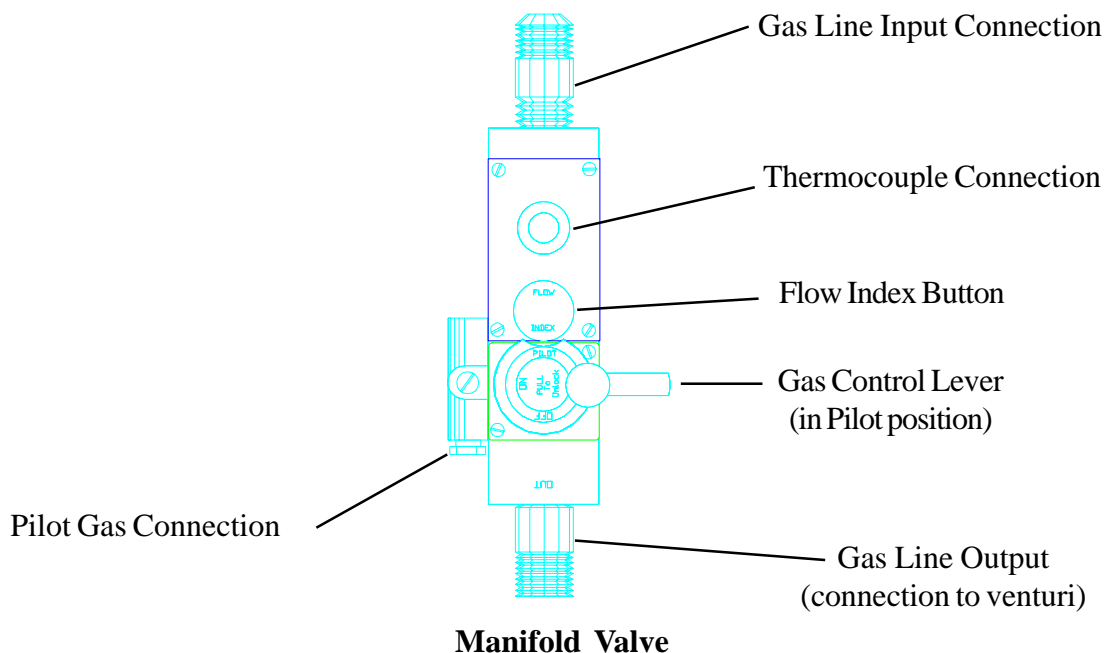

1.7 Natural Gas Flow Table

Gas	Heating Value in BTU/ft ³	Gas Flow per Burner (40,000 BTU) in ft ³ /hr High Flame Setting
Natural	1040	57.75
Propane	2500	24.00
Butane	2500	24.00

1.7.1 Volumetric Method to Verify the High Flame Setting, Mathematical

WARNING! No other gas equipment can be in operation during this procedure.

Calculation of flow rate E in ft³/hour

$$E = \frac{FP}{H_i}$$

E = Flow rate in ft³/minute

FP = High Flame Power setting in BTU/hr

H_i = Heating value in BTU/ft³

Thus, for natural gas:

$$E = \frac{60,000 \text{ BTU/hr}}{1040 \text{ BTU/ft}^3} = 57.75 \text{ ft}^3/\text{hr} = 0.96 \text{ ft}^3/\text{min.}$$

$$E = 0.96 \text{ ft}^3/\text{min.}$$

Calculation of the natural gas needed in 1 hour by a 45WDG (3 burners) at full power:

$$57.75 * 3 = 173.25 \text{ ft}^3/\text{hr} = 2.89 \text{ ft}^3/\text{min.}$$

The time and the flow measurements should be taken at the gas (flow) meter with a chronometer (stop watch).

To run the test, open the manual gas cock valve, start up the unit according to the start-up instructions on page 24 and set the manifold valves to the high flame setting ("on" position).

Allow the unit to pre-heat (burn) for 10 to 15 minutes. Verify that the flow rate is calibrated to the appropriate flow rate indicated in the table.

1.8 Orifice Diameters, Primary Air Intake Settings, and Pressure Regulators

Gas / Pressure inches W.C.	Main Orifice Ø in drill size	Pilot Orifice Orifice Marking	Primary Air Intake in inches
Natural / 5.5"	5 holes @#55	3211	3/16 " 1/8 " 1/8 "
Propane / 11"	2 holes @#55	3221	3/16"
Butane / 11"	2 holes@#55	3221	3/16"

1.9 Changing Gas Orifices

1.9.1 Changing the Main Gas Orifice

1. The venturi tubes and manifold valves are on the same side as the spit handles.
2. On each venturi, loosen the lock nuts (7/8" wrench) and then move the nut and the air intake cap all the way to the top of the nipple.
3. With a 3/4" wrench, loosen the nipple so that it can be removed from the venturi.
4. With the nipple/orifice assembly off, separate the main orifice from the nipple with a pipe wrench or a pair of pliers.

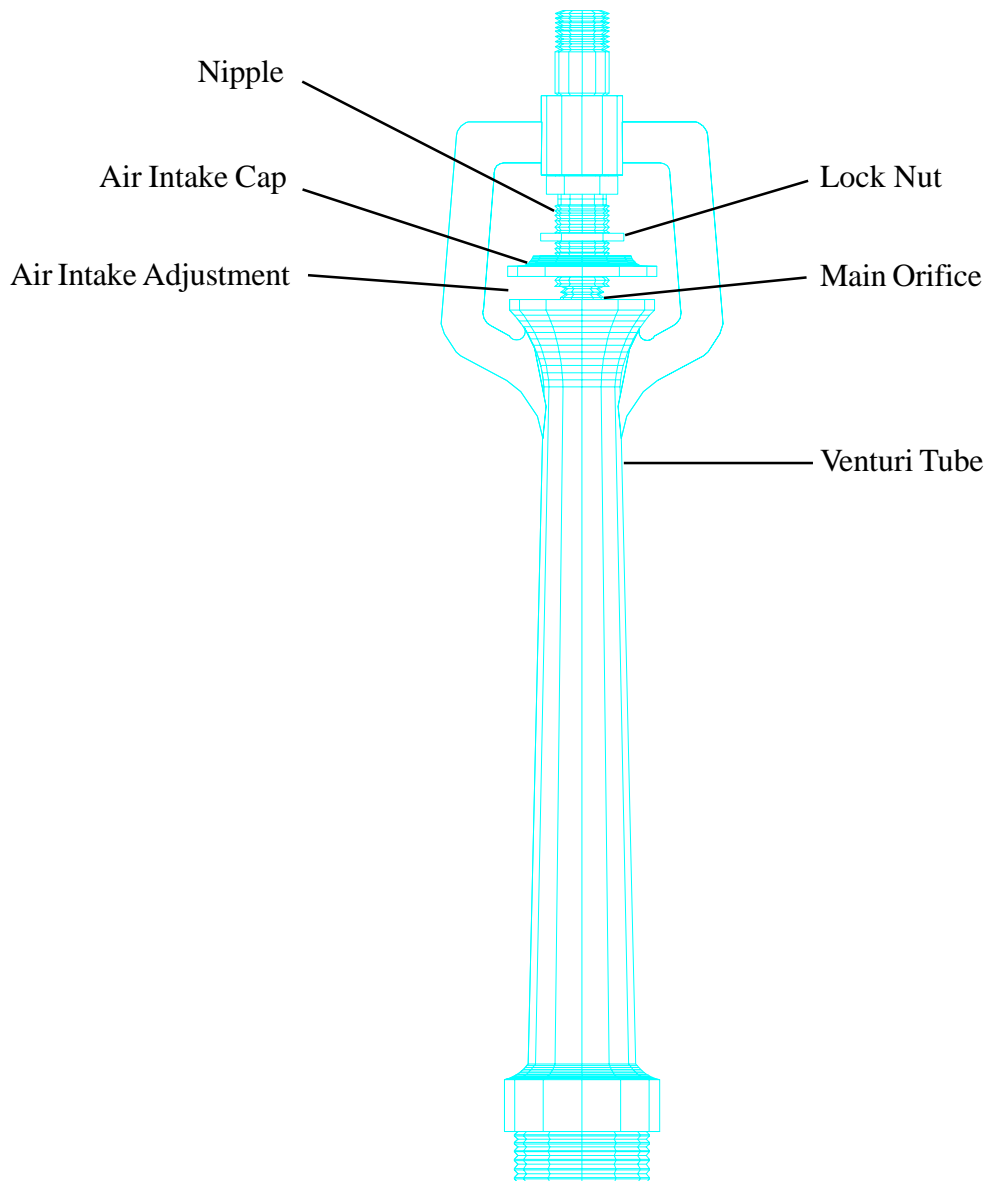

Venturi Assembly

Re-assemble all of the components with the new main orifice. Make sure that the proper air intake adjustment is made for the new type of gas (according to the tables on page 9). The flames should be blue in color, must be stable, and must not "lift off" the burner.

1.9.2 Changing the Pilot Orifice

1. To reach the pilot burner, open the sliding glass doors, the sliding or hinged metal door, remove all spits, as well as all ceramics.
2. Before removing, mark the position of the support bracket on the side wall.
3. Loosen the pilot burner assembly by removing the two screws which attach each pilot burner (support bracket) to the main body of the machine.
4. With the assembly loose, carefully pull the entire assembly forward about 6".

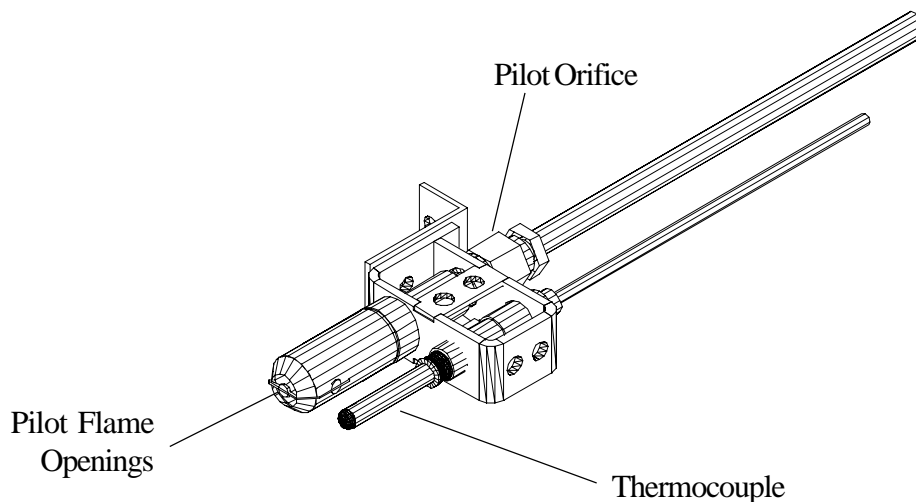

Pilot Burner Assembly

5. Loosen the gas line connection to the pilot orifice with a 7/16" wrench. Carefully separate the gas line from the pilot burner. From the pilot burner, carefully remove the pilot orifice using a 1/2" wrench.
6. Reassemble the pilot burner using the new pilot orifice and place the support bracket in its original position. The following pilot orifices are to be used with each type of gas.

<u>Pilot Orifice</u>	<u>Marking</u>
LPG	3221* Verbally confirm model 45 when ordering.
Natural Gas	3211*Verbally confirm model 45 when ordering.

1.10 Checking the Connected Gas Pressure (Nominal Pressure)

Close the gas cock where the gas line is connected to the machine and attach a manometer to the tap (allen screw) on the gas cock. With the manometer connected, open the gas cock, ignite all burners, and set the manifold valves to "on" or maximum setting. **Along with all other gas appliances at the location in operation, measure the gas pressure.**

This nominal pressure should be 5.5" W.C. for natural gas and 11" W.C. for LPG.

If the measured pressure falls below the range mentioned above, the installer should try to find the cause of the problem and resolve it. A typical source of this problem is that the gas line (pipe) diameter leading up to the unit is too small. If it is not possible to resolve the problem, the local gas company or gas supplier should be contacted so that they can resolve the problem.

If the nominal pressure is below 5.5 " W.C. for natural gas or below 11 " W.C. for LPG, the unit should not be operated. These should be adjusted to the ideal settings using the pressure regulating screw on the pressure regulator.

If the pressure is too high and can not be adjusted downward, check to see if the proper adjusting spring is in place. If this is correct, the regulator membrane may have been ruptured by excessive gas pressure and may have to be replaced. Do not operate the rotisserie if the gas pressure is too low.

If the pressure is too low and can not be adjusted upward, also check the regulator. If this is correct, verify the pressure coming out of the main gas meter or the diameter of the gas pipe feeding gas to the unit. If the gas line is under-sized, the appropriate pressure may not be reached. Do not operate the unit if the pressure falls below 5.5" W.C.

After the pressure has been set, close the gas cock once again, remove the manometer, seal the pressure regulator, and then re-open the gas cock.

WARNING: After an installation, repairs, or maintenance, make sure that there are no gas leaks anywhere in the gas lines or system.

1.11 Maintenance, response to technical problems, reasons for problems and solutions

Should a technical problem arise for any reason, shut off the machine and call for technical service.

A routine maintenance should be carried out at least once a year. Contact your local, certified service company for maintenance.

Problem	Cause	Solution
Burners do not ignite.	a. No gas flow. b. Gas container too cold especially with butane. Water in gas freezes in gas regulator.	a. Make sure that all gas valves are open and that gas is reaching unit. b. Remove and control the gas valve at the connection (manual) or the LPG pressure regulator. Contact gas company or distributor.
Pilot burner ignites. Main burner initially ignites, but then goes out.	a. Thermocouple tip is not enveloped by pilot flame. b. Thermocouple is not heated enough by flame or it is being heated along the entire length too much. c. Primary air intake blocked or must be adjusted. d. Thermocouple is loose at one of the connections. e. Defective thermocouple.	a. Adjust thermocouple position. b. Only the themocouple tip should be enveloped by the pilot flame and heated. The pilot flame must be strong and blue in color. c. Clean or adjust opening according to table in page 9. d. Tighten all thermocouple connections. e. Replace thermocouple (service co.).
Burners too weak.	a. Gas pressure too low. b. Wrong orifice size.	a. Contact service or gas company. b. Install correct orifices.
Burner back-fires.	Too much primary air.	Adjust the primary air intake. (contact service company)
Pilot flame does not stay on.	a. Flames on pipe burners disrupting pilot flame. b. Defective thermocouple.	a. Block off holes on the main burner pipe directly below the pilot burner. b. Replace thermocouple (service co.).

1.12 Testing or checking for safety

After a conversion, a new installation, or after a repair, it is important that the unit be tested to insure that it operates properly. This should include the following:

Test for gas leaks.

Check that the unit has enough clearance behind and to the sides.

Check that enough primary and secondary air is available (strong blue flames).

Check for potentially flammable objects or potential flammability problems.

Check the gas distribution systems.

Check for proper ventilation and exhaust.

Check for proper room ventilation.

When first installing, after repairing, or after cleaning the units, it is important to make sure that all components are properly in place.

- a. There should be a total of 9, evenly spaced ceramic bricks sitting above each main pipe burner.
- b. The ceramics **must** be sitting directly on the burners. These ceramic bricks should also be placed so that they fit between the ceramic support rods.
- c. The burner pipes should not have any holes (flames) directly below the pilot burner assembly. If holes (flames) are present, they will overheat the thermocouple or blow out the pilot flame, preventing the main burner from staying lit.

1.14 Description of the Electrical Connection

The electrical connections are to be made in accordance to local and national codes.

All gas machines operate with 120 Volt, single phase, 60 Hz. A NEMA 5-15P plug is supplied with the units.

All pertinent electrical information can be taken from the electrical diagram.

1.15 Electrical Diagram - All Models

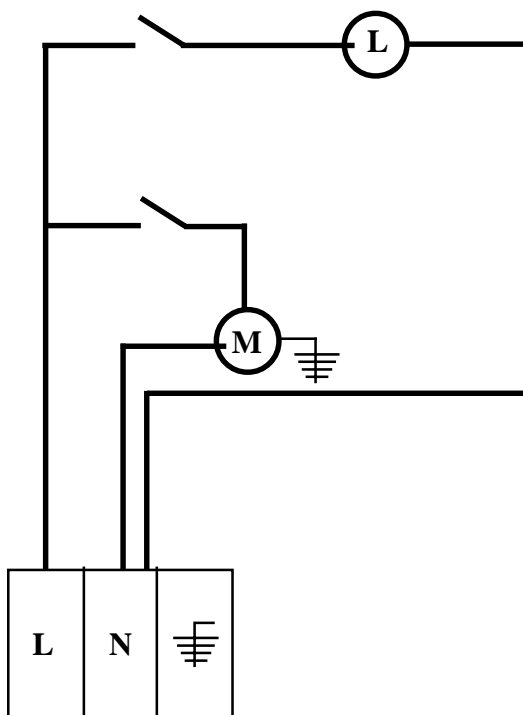

1.16 Parts List for N/4 5WDG

Item	Qty.	Description	Material	Length	Size	Manufacturer
113	39	Ceramic Radiants (Single Face)	Ceramic			Hickory
	1	Accordian Door (Option)	SS			Hickory
120	2	Drip Pan45	SS			Hickory
121	2	Drip Pan Plug	Brass			Hickory
122	2	Drip Pan Receptacle	Brass			Hickory
131	2	Fiber Motor Worm Gear	Fiber			Hickory
409T	1	Glass Track, Top	SS			Hickory
409B	1	Glass Track, Bottom	SS			Hickory
410	2	Glass Trolley 45	Alum.			Hickory
	2	Handle 45	Alum.			Hickory
150	2	Lamp Par, 120 V				Hickory
155	2	Motor, 1/3 HP - 120V				Hickory
157	2	Motor Worm Steel	SS			Hickory
158	33	Oil Lite Bushing	Brass			Hickory
159	6	Pillow Block Bearing 5/8"	SS			Hickory
414	2	Reflector Panel 45WDG Curved	SS			Hickory
415	3	Reflector Panel 45 WDG Flat	SS			Hickory
182	1	Shaft 5/8"	SS			Hickory
184	22	Shaft Worm	Nylon			Hickory
420	2	Spit Plate, N/45 Exterior	SS			Hickory
421	1	Spit Plate, N /45 Center	SS			Hickory
414	1	Top Reflector Single	SS			Hickory
227	3	Venturi Cap	Iron			Hickory
229	3	Venturi Lock Nut 3/8" ID, 3/4" OD	Iron			Hickory
231	3	Venturi Nipple	Steel			Hickory
233	3	Venturi Threading Tube, Brass	Steel			Hickory
234	3	Venturi Tube	Iron			Hickory
232	3	Main Orifice, Nat. Gas	Brass			Hickory
162	3	Pilot Burner (includes pilot orifice)	Steel			Hickory
163	3	Pilot Gas Line	Alum.			Hickory
164	3	Pilot Thermocouple	Copper			Hickory
138	3	Gas Pipe Burner	Steel		1 - 1/2"	Hickory
175	3	Retainer Rod 45 for Ceramics	SS			Hickory
152	2	Lamp Socket	Ceramic			Hickory
214	3	Switch, 1-Pole				Hickory
110	2	Caster w/ brake	Nylon			Hickory
111	2	Caster w/o brake	Nylon			Hickory

1.16 Parts List for N/45WDG (Contd.)

Item	Qty.	Description	Material	Length	Size	Manufacturer
417	9	Spit Regular Complete (with screws)	SS			Hickory
179	2/spit	Roll Pin 1/8" Stainless	SS			Hickory
190	9	Spit Regular, without collar	SS			Hickory
191	9	Spit Collar	SS			Hickory
192	9	Spit Gear	Nylon			Hickory
419	9	Spit Handle, 6" Short	Nylon			Hickory
185	4/Spit	Skewer Double	SS			Hickory
186	2/Spit	Skewer Single	SS			Hickory
219	6/Acc.	Thumb Screw	SS			Hickory
408	2	Tempered Glass 30"x33 3/4"	Tempered Glass			Hickory
407	2	Glass Frame 45	SS			Hickory
165	1	Pressure Regulator 3/4"	Alum.		3/4"	Maxitrol
7A	1	Pipe	Steel	3.5"	3/4"	Hickory
135	1	Gas Cock Valve	Steel		3/4"	
7B	1	Pipe	Steel	6"	3/4"	Hickory
7C	3	T-Connector	Steel		3/4"	Hickory
7D	6	Nipple (Adapter 3/4" to 3/8")	Steel	1.7"		Hickory
132	3	Flexible Pipe	SS	4.25"	3/8"	Dormont
180	3	Manifold Gas Valve	SS		3/8"	Baso
7E	3	Nipple	Steel	1.5"	3/8"	Hickory
226	3	Venturi Assembly	Iron		3/8" - 1-1/2"	Hickory
228	3	Venturi Elbow, 90°	Iron		1-1/2"	Hickory
7F	1	Pipe	Steel	14.5"	3/4"	Hickory
7G	1	Pipe	Steel	16"	3/4"	Hickory
7H	1	Pipe Cap (threaded)	Steel		3/4"	Hickory

The following parts are not shown in the diagrams:

123	1	Electrical Grounding Cap			Hickory
		Electrical Wire			Janor Wire
	1	Connection Cable			TIP Products
104	1	Contact Section 242 (terminal)			Buchanan
105	1	Contact Section 250 (end-piece)			Buchanan

*All components are inventories and sold through Hickory Industries and their distributors and dealers.

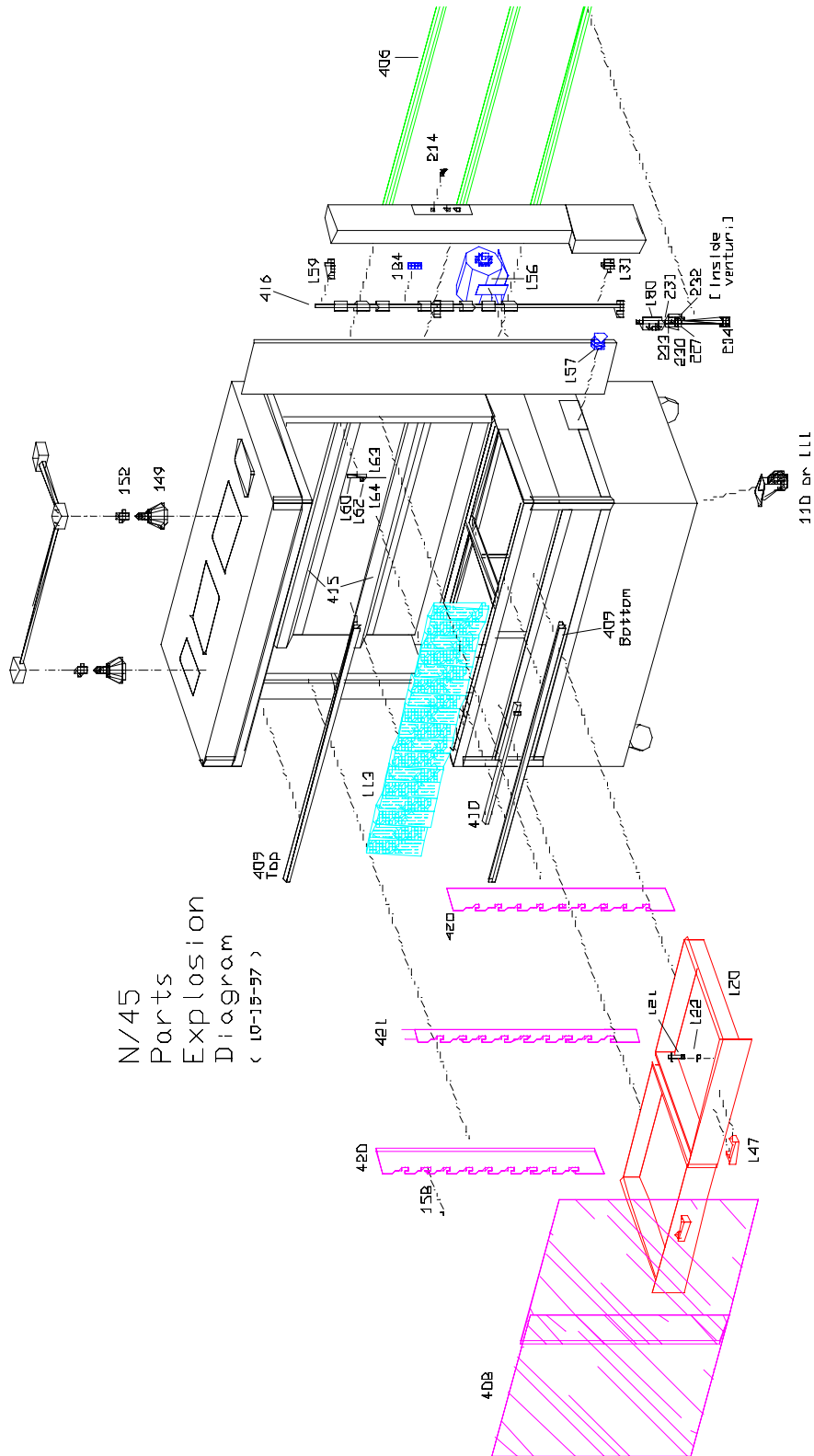

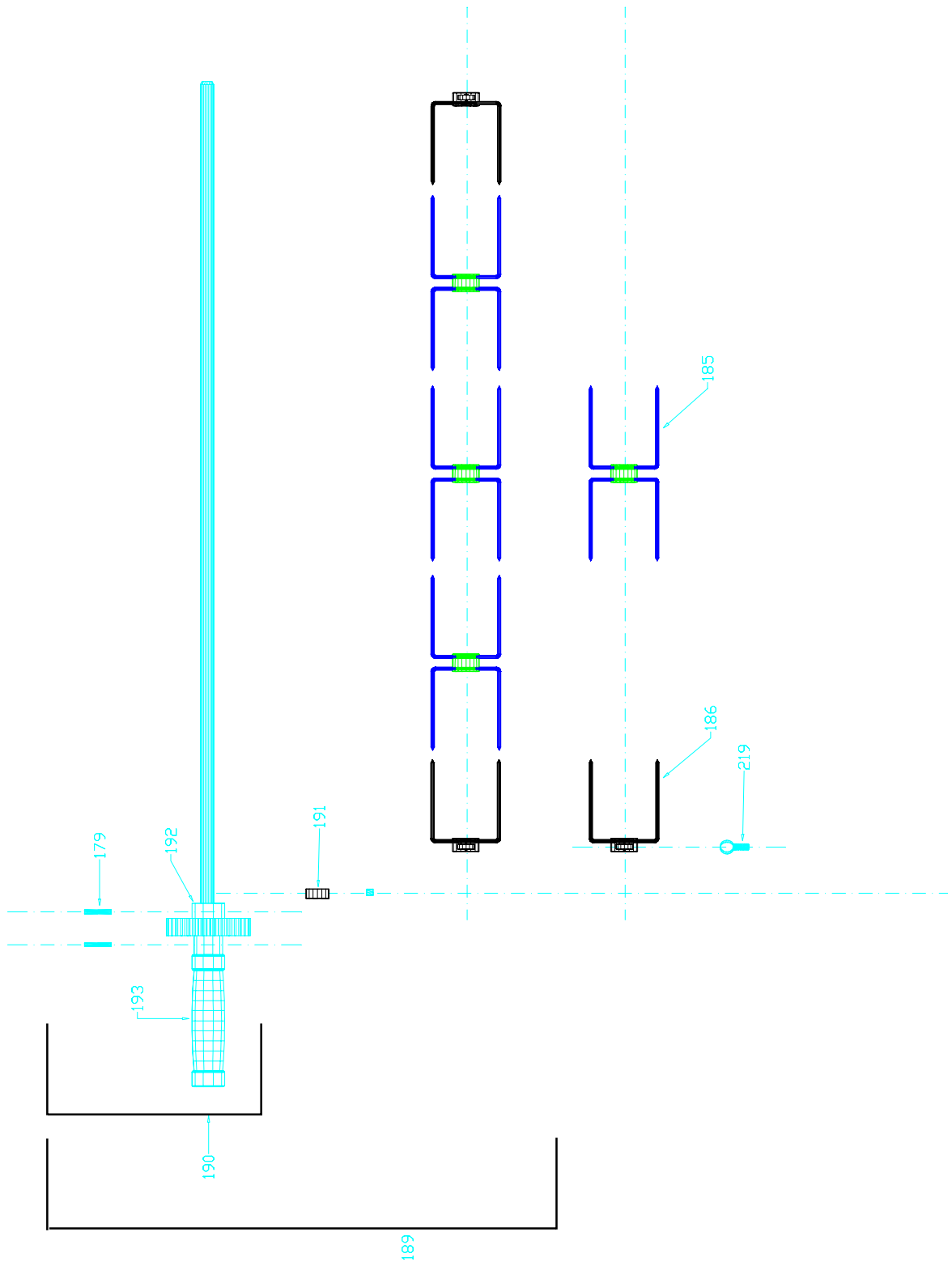

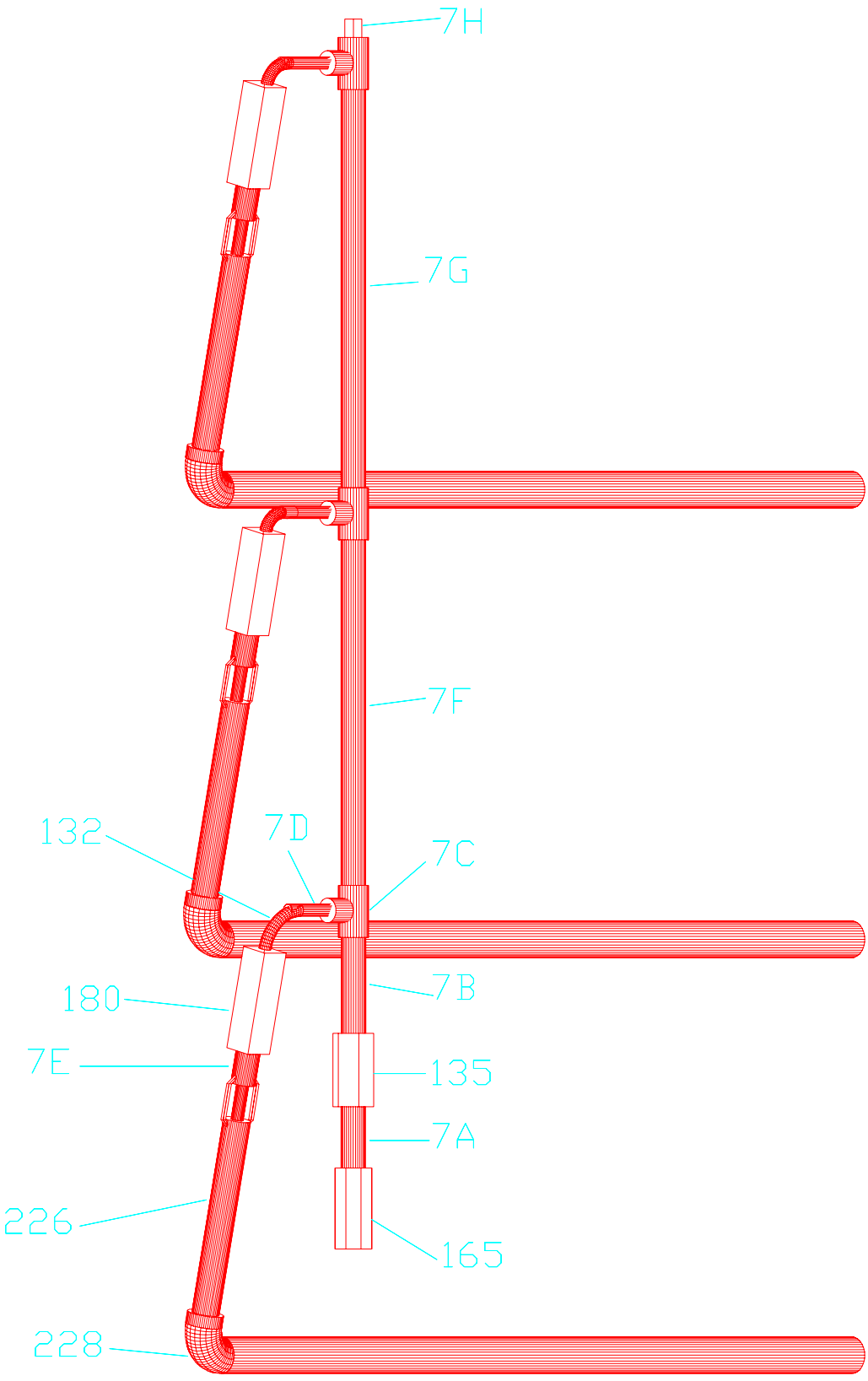

II. Operating Instructions

1.0 Start Up

- a. Switch the exhaust hood to on.
- b. Open the gas cock at the rear of the machine.
- c. Turn the knob on the manifold valve to the "pilot" position.
- d. While pressing the "flow index" button down, place a match, or other type of ignition method, to the pilot burner until it is lit. Keep the knob pressed down for at least 40- 60 seconds so that the thermocouple tip warms up and the pilot flame remains lit.
- e. Release the knob. The pilot flame should stay on.
- f. Repeat the procedure for the other burners.
- g. Turn the manifold valve knob to the desired setting ("on" must be lined up with the "flow index" button for high flame or maximum heat). The pipe burner should now light up.
- h. Allow the unit to pre-heat for about 15 minutes.
- i. When ready to load the spits with product, turn the light and the motor switches to the on position.

2.0 Shut Down

- a. Turn the manifold valve knobs to the "off" position if all flames are to be shut off. If the pilot light is to remain lit and only the pipe burners are to be shut off, turn the manifold valve knobs to the "pilot" position. Note that to turn the knobs to the "off" position, one must pull out on the locking mechanism on the knobs and then turn the valve to the off position.
- b. After all of the loaded spits have been removed, turn the motor and lights off.
- c. Close the gas cock at the rear of the machine if the pilot flames are also shut off.
- d. Turn off the exhaust hood.

WARNING! Do not clean the machine or glass while these are hot! Everything should be cooled down before cleaning.

3.0 Working with the Rotisserie

A. Cooking Temperature

The desired temperature in the rotisserie can only be set with the manifold valve knob. Setting "on" is for the high flame setting and represents about 540°F. The grilling temperature can be reduced by turning the knob counter clock-wise (CCW), towards the "pilot" position.

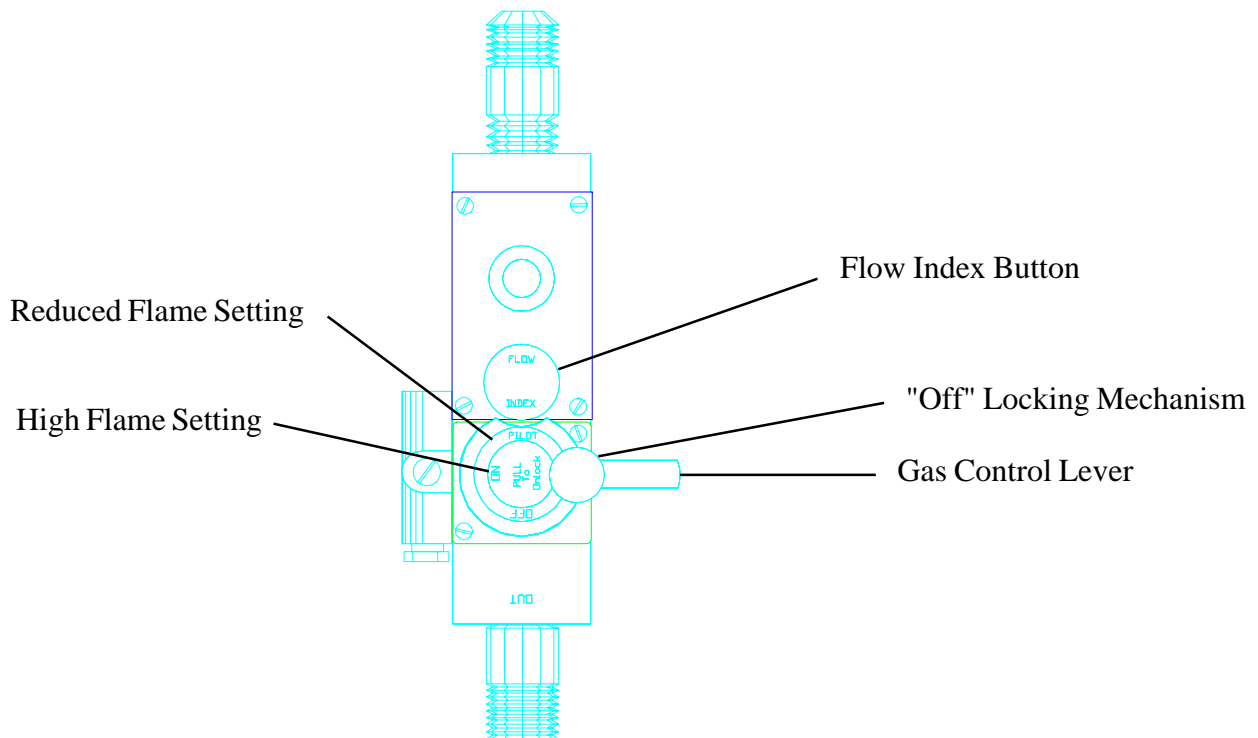

Manifold Valve Knob in "Pilot" Position

As a general rule, the higher the grilling temperature, the shorter the cooking time. However, when working with the Old Hickory rotisserie, one must consider that the temperatures will vary from top to bottom. The top of the unit will have higher temperatures due to the natural convection. The cooking temperatures indicated above refer to the top section of the machine. For this reason, the product on the top spits will be cooked faster than the product on the lower spits.

This factor allows for continuous cooking. As the top spits are ready, they should be removed. The spits directly below should then be moved up one spit position, thus freeing a spit position at the bottom of the unit. This bottom position can then be loaded with fresh, raw product. By loading raw product to the bottom, there is no danger of cross contamination.

WARNING: The only way to be sure that the product is completely cooked is by taking the internal temperatures. For example, with poultry, the internal temperature must be at least 185°F at the inner side of the thigh.

For example, when preparing chicken.

4.0 Cooking Times

<u>Product</u>	<u>Cooking Time</u>	<u>Temperature</u>
Chicken	45 - 60 minutes	"ON"
Turkey	120 - 170 minutes	1/2 power increase to "ON" for last 20 min.
Ribs	20 - 45 minutes	"ON"
Beef Roast	45 minutes (to 104°F)	"ON"
Pork Loin	45 minutes (to 135 °F)	"ON"
Salmon	20 - 30 minutes	"ON"
Duck	120 minutes	1/2 power - 105 minutes "ON" - 15 minutes
Vegetables (Zucchini)	20 minutes	"ON"
Potatoes	40 minutes	"ON"

5.0 Spitting Chickens

The most important part in getting started with a rotisserie is knowing how to properly spit the product. This is quite easy, but it must be learned! As an operator, you will become an expert in spitting chickens within half an hour! There are two types of commonly used spits: the angle spit and the regular spit. The following pages describe and show how spitting is done with both these types of spits.

5.0 Spitting Chickens

A. Using Angle Spits

Hickory Industries, Inc.

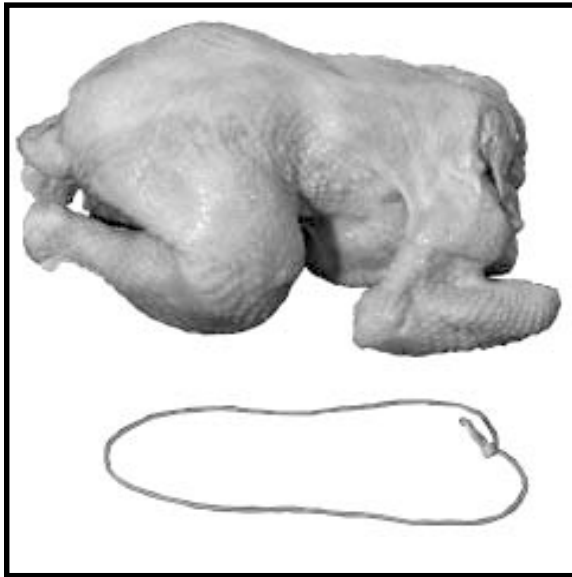

Figure 1. Chickens Ties

When using a “V” or angle spit, it is very important to tie or truss the product being cooked. This prevents the product from moving around the spit and also prevents damage by preventing the legs and wings from flopping. In this section, we will show how to properly truss a chicken. It is important to use a tie to fit the size of the product. In this case, we are tying a 2 ³/₄ lb. chicken with a 6” tie.

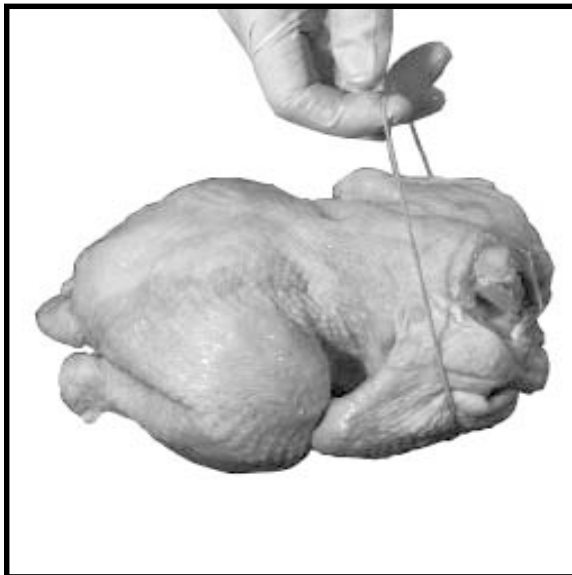

Figure 2. Trussing Wings

With the back of the chicken facing up, take the tie and wrap it around the breast, making sure to tuck the wings against the breast. Pull on the tie as pictured. You will also need to hold the chicken with your other hand.



Figure 3. Trussing Accross Back

While pulling on the tie, cross the strings so that you make an “X” across the back of the chicken. With the “loop” in your hand, you will now need to tie the legs of the chicken.



Figure 4. Trussing Legs

While pulling on the tie, loop the strings over the legs of the chicken.



Figure 5. Trussed Legs

Make sure that both legs are securely held by the tie.



Figure 6. Trussed wings

Make sure that both wings are securely held by the tie against the breast of the chicken.



Figure 7. Pop-up Thermometer

The only way to tell if a chicken is done is take the internal temperature. Since it can be difficult to probe the chickens while they are in the rotisserie, we recommend the use of pop-up thermometer. These inexpensive items should be placed in the thickest part of the chicken, which is the breast. The thermostat will “pop-out” when the internal temperature reaches 185° F.



Figure 8. Chicken Ready to Spit

With the chicken trussed and the pop-up thermometer in place, the chicken is ready to be spitted with an angle spit.

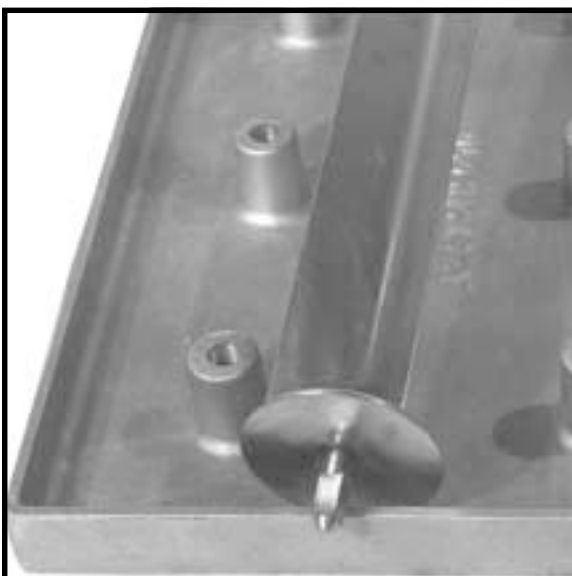

Figure 9. Spitting Accessories

In order to make the use of the angle spits fast and easy, we offer an accessory called a Spit Holder (Hickory Part 195). This aluminum plate offers six holes where the base (square-end) of the angle spit can be inserted.

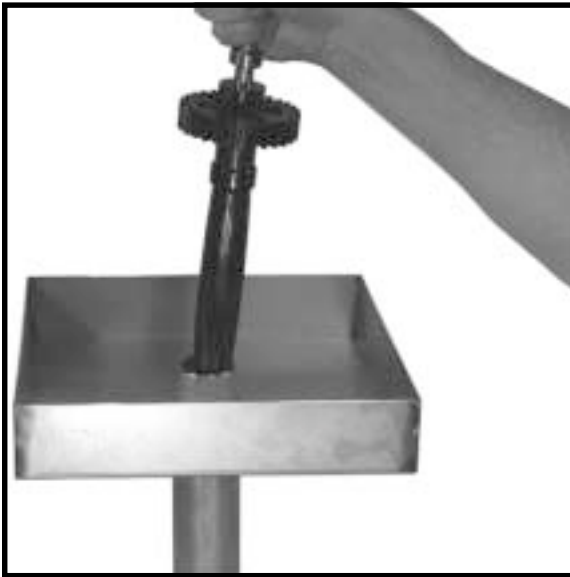

Figure 10. Using the Angle Spit

Insert the bottom (handle) of the spit into the Spit Holder.

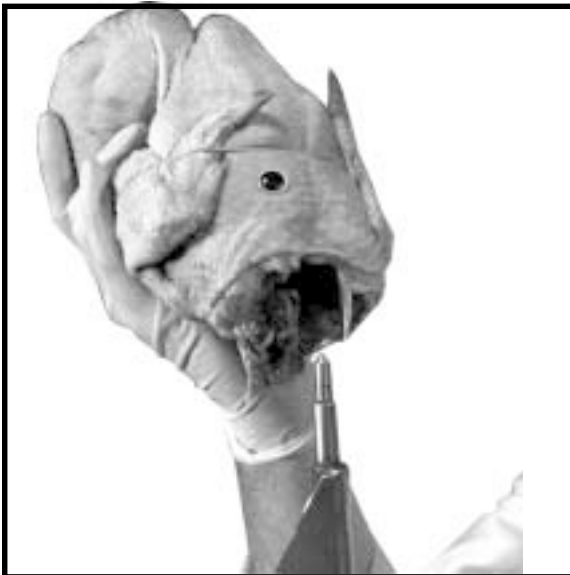

Figure 11. Spitting a Chicken

Spit the chicken through the cavity. The chicken should be inserted through the “head” (or at least where the head used to be) first.

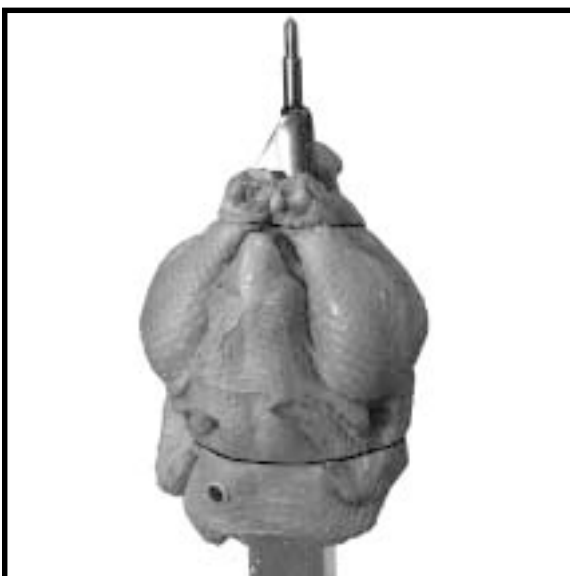

Figure 12. Chicken Position on Spit

When spitting the chicken, make sure that the breast is sitting on the flat, exterior side of the spit. Notice on the picture how the breast is not directly on the rounded corner of the spit, but above one of the flat parts of the “V”. It is also important to note that the legs (and the tie) must sit on the same flat side of the spit. This picture shows exactly how the chicken should look when spitted.

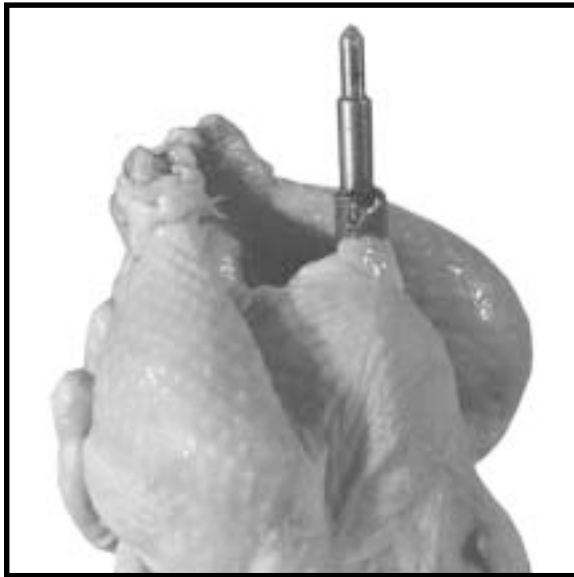

Figure 13. Incorrectly Spitted Chicken

This picture shows a chicken with the legs improperly placed. Note how the chicken seems to hang to one side. When spitted this way, the chickens will tend to “bounce” up and down causing the chicken to break-up.



Figure 14. Complete Spit

After inserting the first chicken, push it all the way to the bottom of the spit and add the next chicken. Depending on the size of the birds and on the rotisserie model, each spit will accommodate three to four $2\frac{3}{4}$ lb. chickens. Once completed, the spit is ready to be placed in the rotisserie.

B. Using Regular Spits



Figure 15. Inserting Single Bottom Skewer

Attach a *single skewer* with a *thumb screw* at least 1/2" from the square end of the spit. The skewer must be on the round section of the spit.

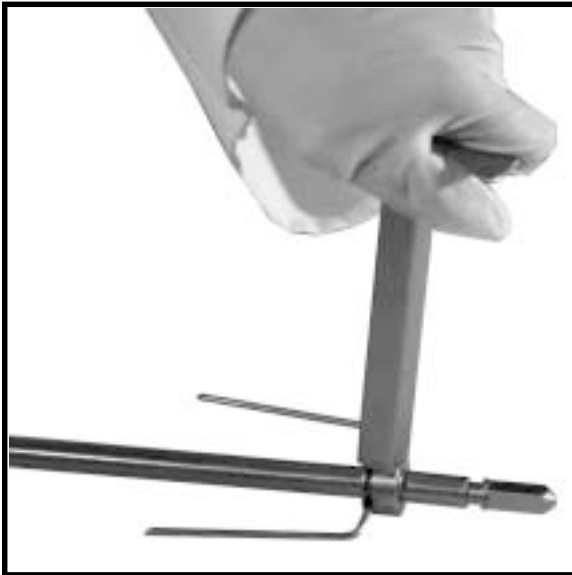

Figure 16. Fastening Bottom Skewer

Use the "T" shaped tool supplied with the unit to tighten the thumb screw. This will prevent the bottom skewer from sliding off the screw.

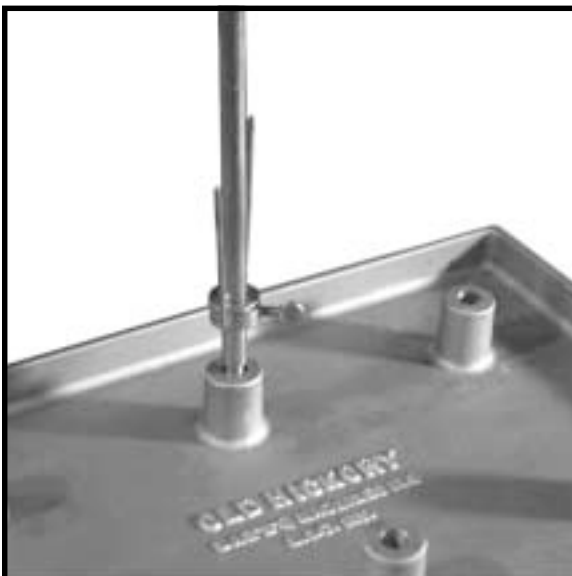

Figure 17. Using the Spit Holder

Even though the chickens can be spitted on a work table, the use of the Spit Holder (Hickory Part 195) will make the spitting process much easier.

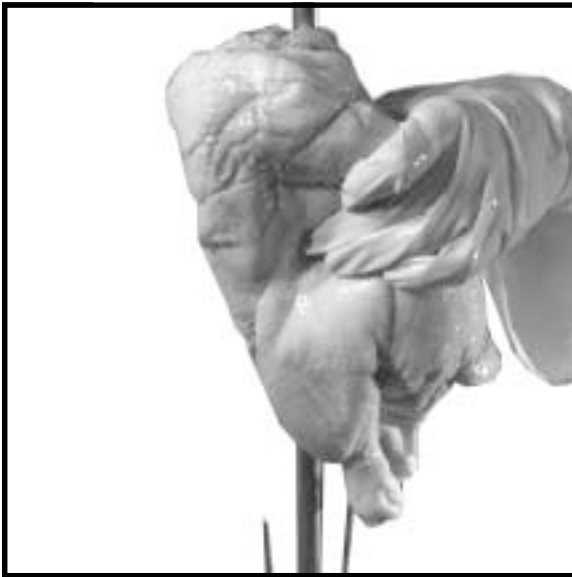

Figure 18. Inserting Chicken

Take the chicken, with the drumsticks in the direction of the attached *skewer*, and slide the *spit* through the cavity of the chicken.



Figure 19. Tucking the Legs

The legs must be tucked between the skewer prongs and the center spit. Note that the bottom of the drumstick is what is being locked in place.



Figure 20. Pressing Chicken Towards Skewer

When viewed from the breast side of the chicken, the bottom of the drumstick is being pushed back while the meaty part of the leg is “puffed up” for better presentation. Note that the skewer is not going straight through the drumstick!



Figure 21. Locking Wings

The wings must be locked or tucked in place. **When using the models N/5.5 and N/10.10, the locking method (pictured here) is only recommended with birds up to 2³/₄ lbs!** With larger birds, the wings must be tucked under the breast, with elastic ties or “wing tuckers”. If the wings are locked on large birds, the wings on the adjacent spits will rub or catch, preventing the spits from rotating freely. This will cause the wings to break off or the gear mechanism to jam.

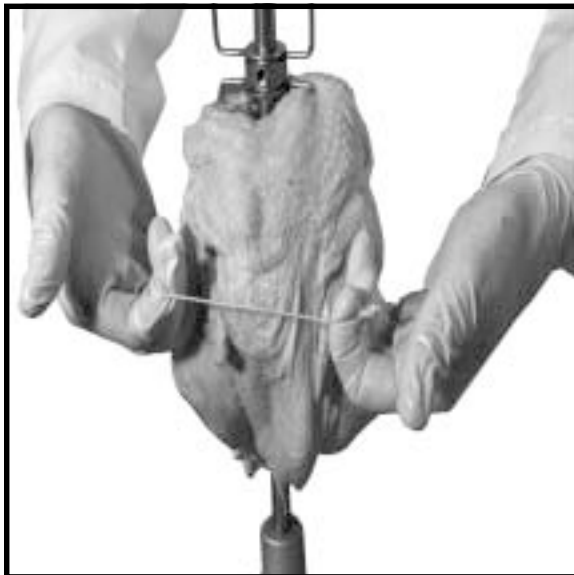

Figure 22. Tucking Wings

With larger birds, the wings must be tucked under the breast, with elastic ties or “wing tuckers”.

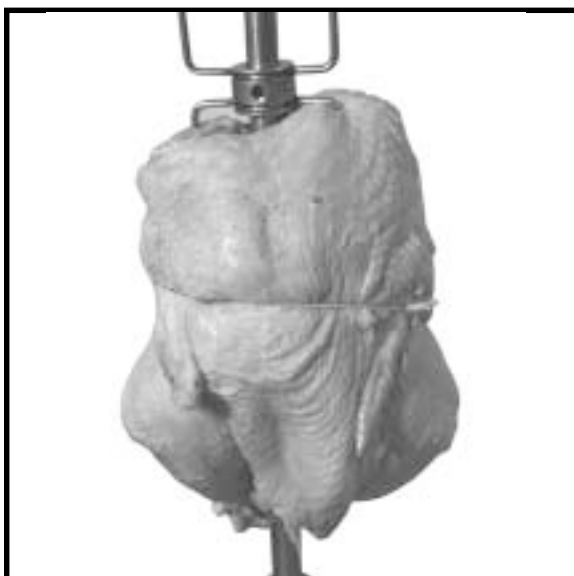

Figure 23. Tucked Wings

Notice how the wings are tucked against the breast. By “tucking” instead of “locking” the wings, the working or rotating diameter of the chicken has been reduced.

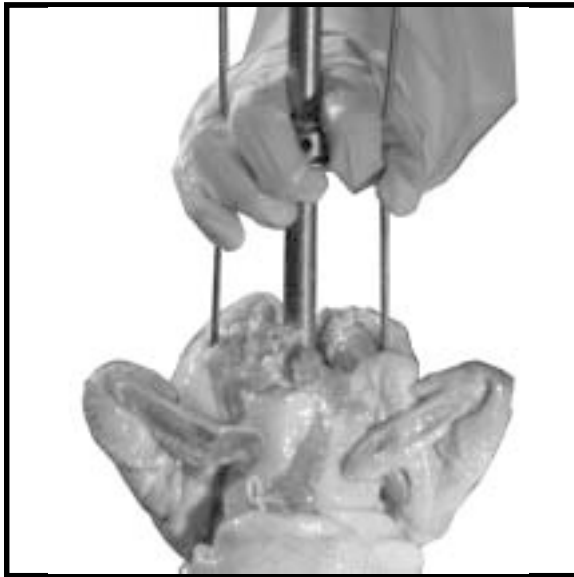

Figure 24. Inserting Double Skewers

With the first chicken in place, insert a *double skewer* down the length of the *spit* into the shoulders of the first chicken. **No *thumb screw* is required for the *double skewers*!**

WARNING! When driving the double skewer into the chicken, do not exert pressure from the end of the prongs! These are sharp and will pierce a finger or hand if not careful. Only apply pressure at the bottom of the "U" shaped half of the skewer!



Figure 25. Double Skewer in Place

With the double skewer in place, insert the next chicken down the length of the *spit* and position the chicken as previously described.

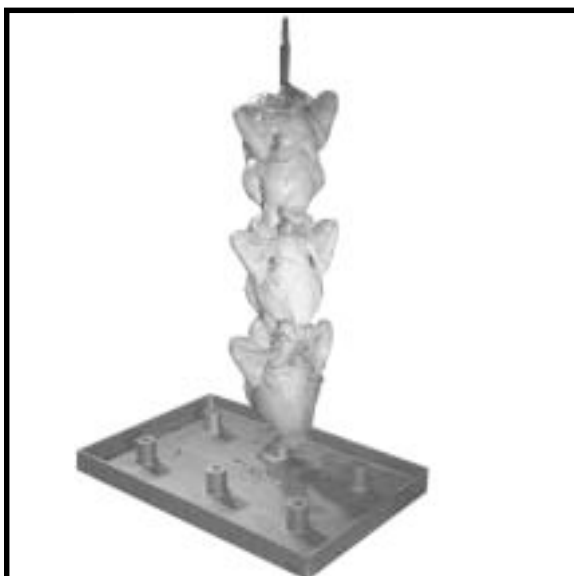

Figure 26. Loaded Spit

When the loading of the chickens is complete, the end of the spit must be locked in place with another single skewer.

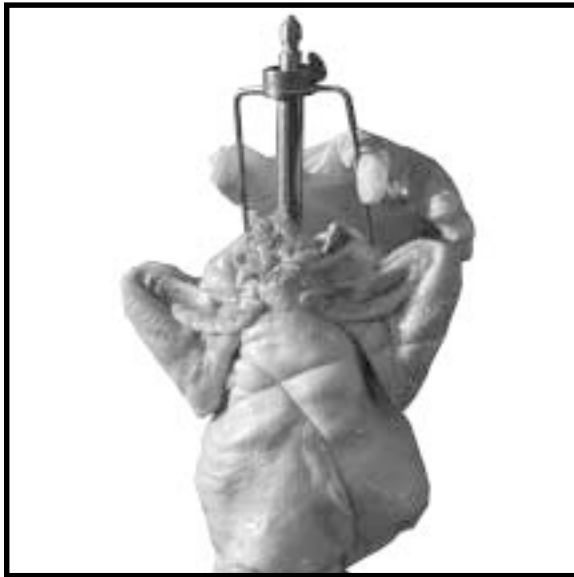

Figure 13. Completing the Load

Slide a *single skewer with a thumb screw* into place from the top,



Figure 14. Tightening Final Skewer

Compress the chickens by exerting pressure on this last skewer, and tighten the thumb screw securely.

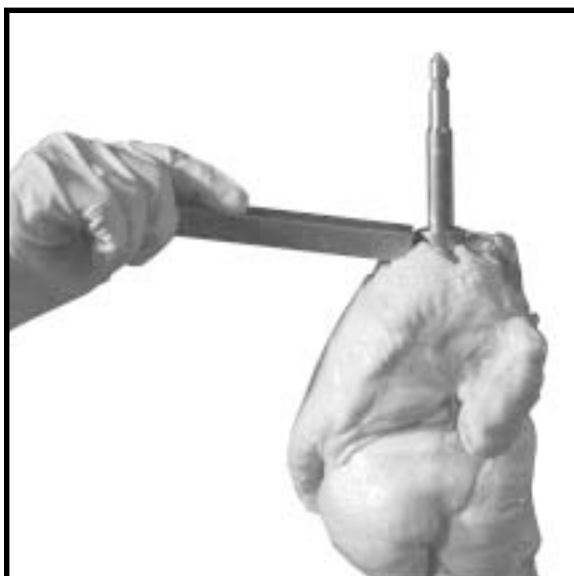

Figure 15. Securing the Load

Tighten the *thumb screws* with Hickory's *thumb-screw tightening tool*. This will prevent the chickens from coming loose.

6. Loading and Unloading Spits

On the N/45G, **you do not need to open the front sliding glass doors of the machine in order to load the spits!** If your unit is equipped with hinged side doors, these must be opened in order to insert and/or remove the spits. With the side(s) open, use a barbecue fork to grab a spit on one end, inside the *single skewers*. You can then use your free hand to hold the spit handle. With the motor switch on or off, **first insert the round end of the spit** and position it on the **oil lite bushing** on the center plate (see Figure 27). Then position the **spit gear** (next to the handle) so that it meshes with the **shaft worm** on the vertical drive shaft. Shift the spit from side to side so that the space formed between the **spit collar** and the **spit gear fits** (falls) onto the **oil lite bushing** on the spit plate. Reverse procedure to unload.



Figure 27

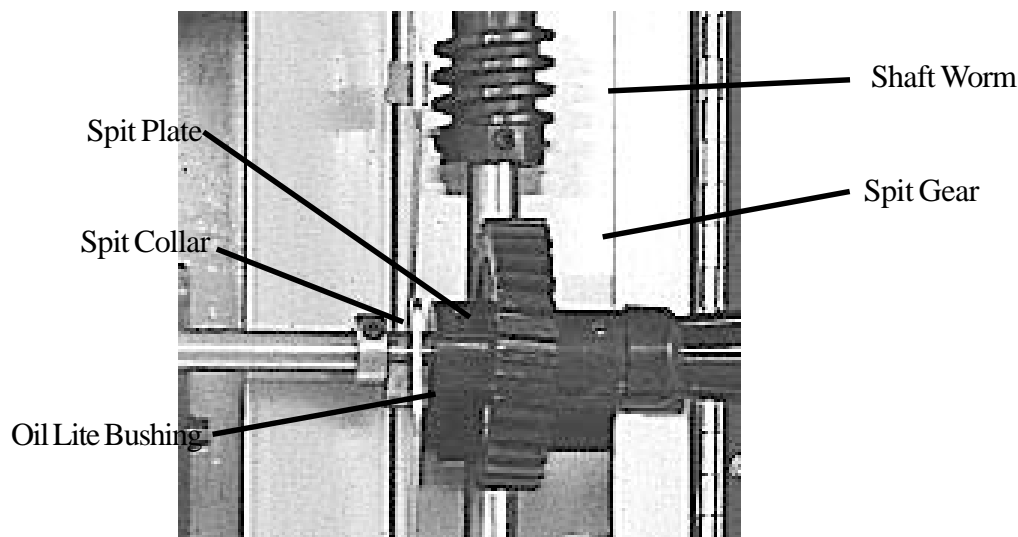

Figure 28

7. Checking Chickens for Doneness

Depending on the model being used, a 2 1/2 lb. chicken will take between 50 minutes and 1 hour 20 minutes to cook in a pre-heated oven when the thermostat is set for *MAXIMUM*. By using a *stem type thermometer*, the operator **MUST** determine the interior temperature of the chicken to test for doneness. Chicken is done at 185°F. ***MAKE SURE TO REMOVE THE SKEWERS FROM BETWEEN THE CHICKENS PRIOR TO SERVING IT TO CUSTOMERS.***

8. Cooking other Products

These units can be used to cook anything from quail to turkeys, pigs, lamb, goat, vegetables, potatoes, fish and much more. The *baskets* can be used for the cooking of chicken parts, brochettes and anything else that cannot go on a spit. A variety of other accessories is also available for specific types of products. Please consult the factory for a complete list of cooking accessories.

9. Cleaning Instructions for Continuous Cook Rotisseries

The most effective maintenance procedure that you can perform will be the daily cleaning procedure

Prior to First Cook:

While the oven is still cold – spray all interior panels with KOTE.

FOR GAS MODELS

Using the shield provided, cover the top row of ceramics and spray the interior of that area with KOTE. Repeat the process covering the remaining rows of ceramics.

DO NOT SPRAY KOTE DIRECTLY ON THE CERAMICS OR THE PILOT LIGHTS.

FOR ELECTRIC MODELS

When spraying KOTE near the elements, adjust the spray nozzle pattern and try not to spray directly on the elements.

Remove the wire rack located above the drip pan and spray the sides of the drip pan with KOTE. Replace the wire rack and spray it with KOTE.

After Each Cooking Cycle

Spray the inside of the glass doors with an approved glass cleaner and wipe with a soft cloth.

Drain the greasy water from the drip pan and replenish with fresh water.

At The End of Each Day

Turn burners valves or element switches to the “OFF” position and allow the oven to cool down.

Remove any spits or baskets – allow them to soak for 15 – 20 minutes, using a solution of warm water and detergent. Rinse clean, following guidelines for rinsing & sanitizing.

Remove the wire rack – and clean it in the sink using a solution of warm water and detergent.

Drain the greasy water from the drip pan and replenish with a solution of warm water and detergent.

Using either a sponge or a cloth - wipe down the interior of the oven with the solution removing any grease/fat. Wipe dry the interior of the oven with a soft cloth.

USE CARE WHEN CLEANING NEAR THE PILOT ASSEMBLY. IF YOU ACCIDENTALLY MOVE THE THERMOCOUPLE, BE SURE THAT YOU SNAP IT BACK INTO POSITION.

Drain the solution from the drip pan, wipe clean and return to the oven along with the wire rack.

Clean the glass with an approved glass cleaner. Do not use abrasives or razor blades as they will mar and/or scratch the surface causing it to break without notice.

Wipe clean the area around the controls with a sponge or soft cloth.

GAS MODELS

RE-LIGHT THE PILOTS AND TURN ON ALL BURNERS (SET TO HIGH).

ELECTRIC MODELS

TURN ON ALL OF THE ELEMENTS.

RUN THE UNIT FOR APPROXIMATELY 5 MINUTES TO BURN OFF ANY CHEMICAL RESIDUE THAT MAY BE REMAINING FROM THE CLEANING PROCEDURE.

Recommendation – now would be a good time to spray the interior of the oven with KOTE. You will be prepared for tomorrow’s cooking cycle.

NOTE: *On a monthly basis, to ensure that the burner is operating efficiently, remove the ceramics and use a paper clip to clean any debris from the burner openings. Additionally the venturi air inlet gap needs to be cleaned. This can be done using a paring knife or business card. Refer to the operating manual.*

10. Maintenance Procedures for Continuous Cook Rotisseries

The most effective maintenance procedure that you can perform will be the daily cleaning procedure.

Monthly:

To ensure that the burner is operating efficiently, remove the ceramics and use a paper clip to clean any debris from the burner openings.

To ensure proper air/gas mixture, the venturi air inlet gap needs to be cleaned. This can be done using a paring knife or business card. Refer to the operating manual.

Every 6 Months:

To ensure that the shaft worm nylon gears properly mesh with the spit gears, place a spit into each spit position with the motor running. If the gears jump or do not align properly, adjust them using the allen wrench provided – **DO NOT OVER TIGHTEN THE SCREWS.**

Every 12 Months:

Inspect the spit plates and verify that the brass oil lite bushings are in place for each spit position. Replace any worn or missing bushings.

Remove the glass and inspect for scratches and or chips. If any are found replace the glass as soon as possible. Also, inspect the glass trolleys. If they are worn, replace them.

Units with sliding side doors – the upper and lower slides needed to be greased.

III. CRITICAL CONTROL STEPS FOR PREPARATION AND COOKING OF BARBECUE CHICKENS

1. Clean and sanitize preparation sink.
2. Clean and sanitize spits, skewers, and thumbscrews.
3. Use only the designated sink for raw product.
4. Rinse off chickens in the preparation sink.
5. Follow product spit-up procedure in manual.
6. Load spitted product into machine. Follow loading instructions in manual.
7. Thoroughly wash and sanitize hands before touching switches and/or dials.
8. Follow operating instructions for oven operation.
9. Check product for doneness as per instruction manual.
10. Follow unloading procedures. Use a designated surface for cooked product only. Insure that no cross contamination occurs with any surface previously used for raw product, including employee hands.
11. If placing product in a display warmer, ensure that the product temperature (*NOT WARMER TEMPERATURE*) does not fall below 140°F. Warmer temperature insures that the ambient air temperature in the warmer is correct, but does not insure product temperature.
12. Advanced preparation and storage of spitted product should be in an authorized, properly covered and maintained bin set aside for storing spitted product in the walk-in refrigeration unit.
13. ***THE MOST CRITICAL STEP IN THE PREVENTION OF CROSS CONTAMINATION IS THE HUMAN HAND. THEREFORE, HANDLING RAW PRODUCT AND THE WASHING OF HANDS IS THE MOST CRITICAL CONTROL STEP IN PREVENTING CROSS CONTAMINATION.***

IV. WARRANTY

HICKORY INDUSTRIES WILL WARRANTY ALL ROTISSERIES FOR ONE YEAR FROM THE DATE OF ORIGINAL INVOICE. WARRANTY INCLUDES ALL PARTS EXCEPT BULBS AND GLASS. WARRANTY CONDITION IS THAT ALL WARRANTY DOCUMENTS MUST BE SIGNED AND MUST BE RETURNED TO HICKORY BY THE USER AFTER RECEIPT OF THE ROTISSERIE. THE COMPANY (HICKORY) RESERVES THE RIGHT TO REVIEW ALL WARRANTY CLAIMS BY ITS AUTHORIZED REPRESENTATIVE AND IF NEGLIGENCE OR ABUSE IS FOUND, THE CLAIM WILL BE DISALLOWED.